

27 721 970













Passt zu: ELIO, TARA, TARA ULTRA

- mit runder Rosette
- Brausestrahl
- automatischer Umschalter Auslauf/Brause
- Armaturenhöhe 191 mm
- Bohrungsdurchmesser Spülbrause 32 mm
- gewebeumflochtener Brauseschlauch 1500 mm
- Sprayface mit Antikalk-System
- bleifrei

Nur kombinierbar mit 33826790, 32800790, 33826888, 32815888, 20815892, 33826875.

Eigensicher gegen Rückfließen.

	Chrom	27 721 970-00
	Platin gebürstet	27 721 970-06
	Platin	27 721 970-08
	Messing (23kt Gold)	27 721 970-09
	Dark Chrome	27 721 970-19
	Messing gebürstet (23kt Gold)	27 721 970-28
	Schwarz matt	27 721 970-33
	Champagne gebürstet (22kt Gold)	27 721 970-46
	Champagne (22kt Gold)	27 721 970-47
	Chrom gebürstet (Edelstahl-Look)	27 721 970-93
	Dark Platinum gebürstet	27 721 970-99

27 721 970

mm [inches]

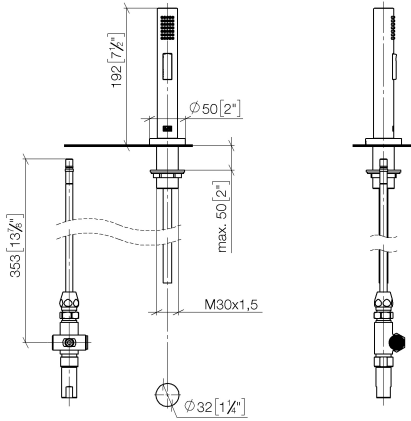

Durchflussdiagramm



Zertifikate

LGA_18901.

Belgaqua_21-027-
27_3.

LGA_29572.

IAPMO_6397.

27 721 970

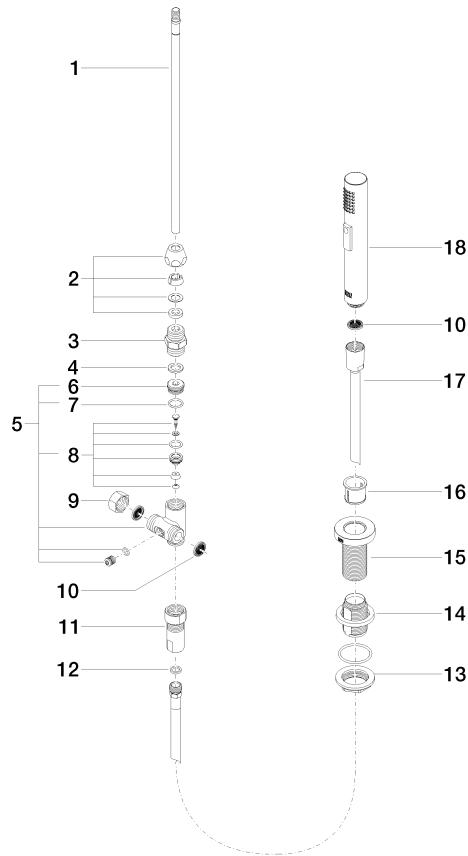

Ersatzteilstückliste

Nr.	Artikelnummer	Benennung	Verbaumenge	Lieferzeit
1	04 24 02 046 01-07	Rohr	1	10
2	90 23 30 040 00-00	Verschraubung	1	10
3	90 24 03 168 00 90	Nippel	1	2
4	90 14 20 002 00 90	Dichtung	1	2
5	90 17 09 046 10 90	Umstellung	1	2
6	09 24 04 112 10 90	Nippel	1	2
7	90 14 10 033 00 90	Dichtung	1	2
8	90 21 10 031 10 90	Umstellung	1	2
9	04 21 02 006 00 92	Kappe	1	2
10	09 23 01 039 90	Sieb	2	2
11	90 24 03 241 00 90	Nippel	1	2
12	90 14 20 019 00 90	Dichtung	1	2
13	04 30 11 038 66 90	Befestigungssatz	1	2
14	12 720 970 90	Verlängerungsset -	1	60
15	09 30 01 285-00	Rosette	1	10
16	90 18 40 085 00 90	Huelse	1	2
17	90 30 02 062 00-00	Schlauch	1	2
18	04 12 11 158 00-00	Brause	1	10